









-  SUITABLE FOR INCLINED SURFACE INSTALLATION
-  ASYMMETRIC EIGHT WHEELED CARRIAGE
-  C 2 HQ BEARINGS
- mono block** MONO BLOCK EIGHT WHEELED CARRIAGE
-  CARRIAGES CENTER HOLES MILLED NOT LASERED
-  MULTI RIVITED SECTIONS

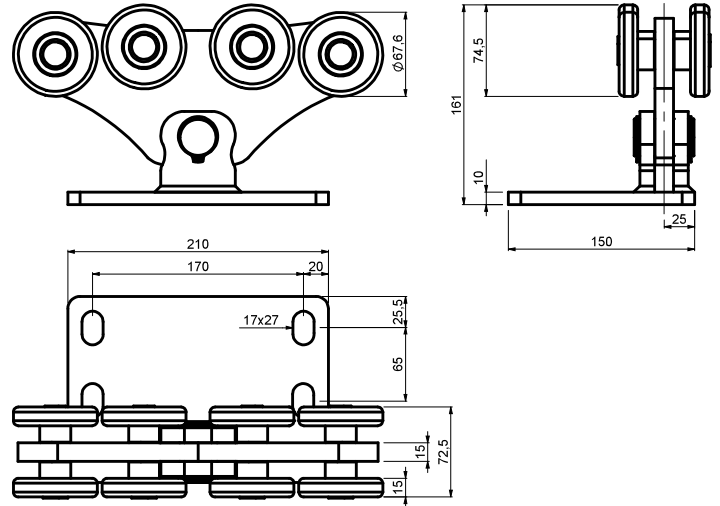

- (GB) EIGHT WHEELED CARRIAGE FOR CANTILEVER GATE
- (D) ROLLAPPARAT MIT ACHT ROLLEN FÜR FREITRAGENDE SCHIEBETORE
- (F) CHARIOT À HUIT ROUES POUR PORTAIL AUTOPORTANT
- (E) CARRIL DE OCHO RUEDAS PARA PUERTA VOLADIZA
- (P) CORREDIÇA DE OITO ROLDANAS PARA PORTÃO CANTILEVER
- (I) CARRELLO A OTTO RUOTE PER CANCELLO AUTOPORTANTE
- (DK) OTTE TRANSPORTHJUL TIL FRITTBÆRENDE PORT
- (NL) ACHTVOUDIG WIELENBLOK VOOR VRIJDRAGENDE SCHUIFPOORT
- (N) ÅTTEHJULS DRIVSKINNE TIL FRITTBÆRENDE PORT
- (S) ÅTTAHJULIG VAGN FÖR FRIBÄRANDE GRIND
- (FIN) KAHEKSAAN PYÖRÄN ALUSTA ULOKEKANNETTEISEEN PORTTIIN
- (PL) WÓZEK 8-ROPKOWY DO BRAM SAMONOŚNYCH
- (SK) VOZÍK OSEM KOLIEČKOVÝ PRE POSUVNÚ SAMONOSNÚ BRÁNU
- (EE) KAHEKSARATTALINE SUPORT KONSOLVÄRAVA JAOKS
- (LT) VEŽIMĖLIS GEMBINIAMS VARTAMS SU AŠTUONIAIS RATUKAIS
- (LV) ASTOŅU RULĻU BLOKS KONSOLVEIDA VĀRTIEM

- (CZ) VOZÍK OSMIKOLOVÝ PRO POSUVNOU SAMONOSNOU BRÁNU
- (RO) CĂRUCIOR PE OPT ROȚI PENTRU POARTA AUTOPORTANTĂ ÎN CONSOLĂ
- (HR) NOSAČ S OSAM KOTAČA ZA KLIZNA DVORIŠNA VRATA
- (RUS) ВОСЬМИКОЛЕШАЯ РОЛИКОВАЯ ТЕЛЕЖКА ДЛЯ ОТКАТНЫХ САМОНЕСУЩИХ ВОРОТ
- (SLO) VOZIČEK Z OSMIMI KOLESI ZA SAMONOSNA DRSNNA VRATA
- (TR) KONSOL BAHÇE KAPISI İÇİN SEKİZ TEKERLEKLİ TAŞIYICI
- (AR) عربة مزودة بثمانى عجلات للوابواب المدعمة
- (CHN) 悬臂门八轮滑架
- (MAL) PENYORONG LAPAN RODA UNTUK PINTU PAGAR JULUR
- (H) NYOLCGÖRGÖS FUTÓKOCSI TOLÓKAPUHOZ
- (IL) קרונית שמונה גלגלים לשער קומזולי
- (BG) КОЛИЧКА С ОСЕМ РОЛКИ ЗА КОНЗОЛНА ВРАТА
- (KO) 8개 휠이 있는 캔틸레버 게이트용 이송대
- (SRB) NOSAČ SA OSAM TOČKIĆA ZA SAMONOSIVU KAPIJU

Art.	A	GUIDE	1pc		CODE
	max. mm		kg	pcs	kg
SPEED MEK	8000	STAGE MB/MZ	9	2	18